

PDA103 TECHNICAL SPECIFICATION	
Rated supply voltage:	110 to 240Va.c. @ 50/60Hz
Rated power consumption:	18W PSU
Maximum RMS output current:	4A @ 1kHz
Maximum RMS load voltage:	5.5V
PDA103C approx. coverage area using the TX2 pre-formed loop:	1.2m <sup>2</sup>
PDA103R/L/S approx. coverage area using 0.5mm <sup>2</sup> loop cable:	50m <sup>2</sup> , i.e. rooms up to approx. 7m x 7m
Recommended number of turns:	Single turn
Recommended loop conductor size:	0.5mm <sup>2</sup> @ < 50m loop length
Frequency response -3dB:	120Hz to 5kHz as per BS EN 60118-4
Input signal level:	Mic: -60dB unbalanced; Line: -27dB stereo unbalanced; Outreach: -10dB balanced.
Input impedance:	Mic: 1k ohm; Line: 100k ohm; Outreach: 20k ohm.
Microphone phantom power:	12Vd.c.
Signal to noise ratio, A weighted:	-62dB
Optical TOS-link receiver (PDA103S kit only):	Up to 24 bit, 96kHz sampling
AGC range (3dB change in output current), reference rated I/P voltage:	10dB
AGC ratio:	20:1
Amplifier mode:	True current mode
Sensitivity level controls:	Mic, Line, Digital (PDA103S kit only), Outreach, Metal Compensation, Level (all rotary pot controls are screwdriver adjustable).
LED indicators:	Limit (Red), Peak (Red), Loop Fault (Red), Power On (Green).
Connectors:	Mic (3.5mm mono jack socket); Line (3.5mm stereo jack socket); Digital (PDA103S kit only); Outreach (4-way pluggable screw terminal); DC in; Loop (2-way pluggable screw terminal).
Dimensions (H x W x D):	35mm x 135mm x 130mm (including controls)
Weight:	380g (amplifier only)
IP Rating (to EN 60529):	IP40
Operating temperature:	0°C to 40°C

# PDA103

## HEARING LOOP AMPLIFIER



PDA103C/R/L  
Kit Version



PDA103S  
Kit Version

## INSTALLATION INSTRUCTIONS

*This equipment must be installed by a suitably skilled and technically competent person. Please read these instructions carefully before installation.*

The PDA103 is a true current mode, hearing loop amplifier. It may be surface-mounted and is designed to cover ticket counters up to 1.2m<sup>2</sup> (PDA103C kit version), or rooms up to 50m<sup>2</sup> (PDA103R/L/S kit versions).

Safety guidelines, important notes and product safety note.....	2
PDA103 kit contents .....	3
Overview of the PDA103 hearing loop amplifier .....	4/5
Typical PDA103C 1.2m <sup>2</sup> counter hearing loop system .....	6
Typical PDA103R/L 50m <sup>2</sup> small room hearing loop systems .....	7
Typical PDA103S 50m <sup>2</sup> domestic TV lounge hearing loop system .....	8
Overview of the outreach plate audio extension system .....	9
Mounting the amplifier .....	9
System set-up and testing .....	10/11
PDA103 technical specification .....	12

© Errors and omissions excepted. No responsibility can be accepted by the manufacturer or distributors of this equipment for any misinterpretation of this instruction, or for the compliance of the system as a whole. The manufacturers policy is one of continuous improvement and we reserve the right to make changes to product specifications at our discretion and without prior notice.

## SAFETY GUIDELINES

The PDA103 amplifier must be sited indoors and **MUST NOT** be subjected to conditions likely to affect its performance.

DO NOT dismantle or attempt to modify the amplifier, there are no user-serviceable fuses or parts inside the amplifier. For repair, contact your supplier.



**WARNING:** The surface of this unit may become hot during continued use.

- 1) Read these instructions.
- 2) Keep these instructions.
- 3) Heed all warnings.
- 4) Follow all instructions.
- 5) **WARNING:** To reduce the risk of fire or electric shock, do not expose this apparatus to rain or moisture.
- 6) Clean only with dry cloth.
- 7) Do not block any ventilation openings. Install in accordance with the manufacturer's instructions.
- 8) Do not install near any heat sources such as radiators, heat registers, stoves, or other apparatus (including amplifiers) that produce heat.
- 9) Protect the power cord from being walked on or pinched particularly at plugs, convenience receptacles, and the point where they exit from the apparatus.
- 10) Only use attachments/accessories specified by the manufacturer.
- 11) Unplug this apparatus during lightning storms or when unused for long periods of time.
- 12) Refer all servicing to qualified service personnel. Servicing is required when the apparatus has been damaged in any way, such as power-supply cord or plug is damaged, liquid has been spilled or objects have fallen into the apparatus, the apparatus has been exposed to rain or moisture, does not operate normally, or has been dropped.

## IMPORTANT NOTES

These instructions are general and cannot be considered to cover every aspect of hearing loop system design and installation.

We recommend you read BS 7594 - Code of practice for audio-frequency induction-loop systems (AFILS) and BS EN 60118-4 - Induction loop systems for hearing aid purposes. Other national standards of design/installation/commissioning should be referenced where pertinent.

 This product has been manufactured in conformance with the requirements of all applicable EU directives.

### Equipment guarantee

This equipment is not guaranteed unless the system is installed and commissioned in accordance with regional or national standards by an approved and competent person or organisation.

## PRODUCT SAFETY NOTE

For safety reasons, the amplifier may shut down to protect it from overheating if too much current passes through its sensitive protection circuitry. This may occur, for example, when the **Peak** indicator remains permanently lit (see Page 11, Step 9).

- 8 With the relevant audio input source(s) active, turn the appropriate **Outreach/Digital/Line/Mic** level control(s) clockwise until the red **Limit** indicator is flashing occasionally.

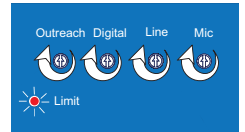

- 9 Turn the **Level** control clockwise until the red **Peak** indicator just lights during periods of high signal level, i.e. when the red **Limit** indicator just lights.



### Product Safety Note:

If the system is set up so that the **Peak** indicator is permanently lit, the audio sound quality will be distorted and the amplifier may shut down to protect it from overheating.

- 10 If high metal content is present in, or near, the hearing loop, the sound heard by the loop listening device may be 'woolly' or 'dull'. To rectify, turn the **Metal Compensation** control clockwise in small increments until a natural balance is achieved.



Note 1: If high metal content is present, the amplifier's area of coverage will be reduced, and further reduced, as the **Metal Compensation** control is turned clockwise.

Note 2: If the **Peak** indicator lights strongly, turn the **Level** control anti-clockwise and then adjust the **Metal Compensation** control. You may have to adjust both these controls several times to achieve most favourable operation.

- 11 Using an hearing loop test receiver, listen to the loop signal in all areas where coverage is required (we recommend you use a Fosmeter Pro for this purpose, see Additional Testing below). If the signal level is not acceptable, adjust the **Level** control in small increments until it is.



## Additional testing

Hearing loop systems require careful testing and calibration prior to operation. BS EN 60118-4 recommends that the achievable magnetic field strength of a hearing loop system over a 'covered area' should be 400mA RMS per metre.

The most efficient way of ensuring this requirement is met is to test and set-up the system using an FPROK hearing loop test kit. This kit includes a handheld Fosmeter Pro 400mA magnetic field strength meter and a loop listener (for measuring background noise, frequency response and metal compensation). Contact your supplier for more information.

## SYSTEM SET-UP AND TESTING



**IMPORTANT: DO NOT power up the system before completing Step 7 below. The amplifier MUST NOT be operated without a loop connected to it.**

- 1 Install the loop cable.  
BEFORE connecting the loop to the amplifier, use a multimeter to check the loop is not shorted to ground at any point. It WILL damage the amplifier if it is.

- 2 Connect the loop cable (supplied) to the amplifier.  
Remove approx. 6mm of the outer insulation from each end of the loop cable, then secure both ends to the screw terminals of the 2-way loop cable connector (supplied). Next, plug the 2-way connector to the amplifier's **Loop** connector.

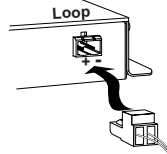

- 3 If relevant, plug the AMT microphone, or an alternative electret microphone, into the amplifier's **Mic** connector.

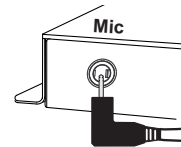

- 4 If relevant, plug the audio line level into the amplifier's **Line** input, or TOS-link connector cable (not supplied) into the amplifier's **Digital** connector.

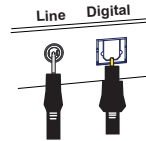

- 5 If relevant, connect the outreach system to the amplifier.  
Remove approx. 6mm of the outer insulation from all cable ends, then secure the ends to the screw terminals of the 4-way outreach connector (supplied). Next, plug the 4-way connector into the amplifier's **Outreach** connector.



- 6 Ensure the amplifier's **Outreach, Digital, Line, Mic, Metal Compensation** and **Level** pot controls are set to minimum by turning them fully anti-clockwise.

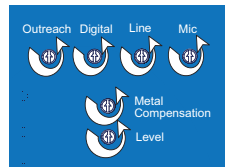

- 7 Connect the plug-top power supply (supplied) to the AC mains socket and then to the amplifier's **DC in** connector.  
Ensure the amplifier's green **Power On** indicator lights.

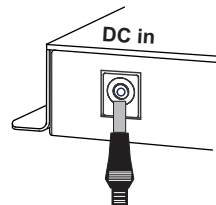

## PDA103 KIT CONTENTS

The PDA103 hearing loop amplifier is available in the following kits.

### PDA103C - 1.2m<sup>2</sup> Counter Hearing Loop Kit:

- 1 x PDA103 hearing loop amplifier
- 1 x 230Va.c. PL1/PSU1 plug-top power supply
- 1 x TX2 pre-formed counter loop cable and fixings
- 1 x AMT tie/desk microphone c/w 1.5m lead and attachments
- 1 x Accessory pack containing the installation instructions (this document), four cable ties, four self-adhesive cable tie bases, one 4-way 'outreach' connector, one 2-way loop cable connector, one 'hearing loop fitted' sticker.

### PDA103R - 50m<sup>2</sup> Small Room Hearing Loop Kit (plated mic version):

- 1 x PDA103 hearing loop amplifier
- 1 x 230Va.c. PL1/PSU1 plug-top power supply
- 1 x APM 'outreach' plated microphone c/w 6m Belden cable
- 1 x 40m of 0.5mm<sup>2</sup> loop cable
- 1 x Accessory pack (as per the PDA103C kit).

### PDA103L - 50m<sup>2</sup> Small Room Hearing Loop Kit (tie/desk mic version):

- 1 x PDA103 hearing loop amplifier
- 1 x 230Va.c. PL1/PSU1 plug-top power supply
- 1 x AMT tie/desk microphone c/w 1.5m lead and attachments
- 1 x 40m of 0.5mm<sup>2</sup> loop cable
- 1 x Accessory pack (as per the PDA103C kit).

### PDA103S - 50m<sup>2</sup> Domestic TV Lounge Hearing Loop Kit:

- 1 x PDA103 hearing loop amplifier (with TOS-link digital connector)
- 1 x 230Va.c. PL1/PSU1 plug-top power supply
- 1 x APL dual phono line level 'outreach' plate c/w 6m Belden cable
- 1 x APS SCART to dual phono connection lead
- 1 x 40m of 0.5mm<sup>2</sup> loop cable
- 1 x Accessory pack (as per the PDA103C kit).

## OVERVIEW OF THE PDA103 HEARING LOOP AMPLIFIER

**Note:** The digital input (3) and digital control (6) shown in the diagrams below only apply to the amplifier supplied with the PDA103S kit which has a TOS-link digital connector.

### General operation

The amplifier mixes and amplifies the microphone, line, digital (PDA103S kit only) and outreach input signals and feeds them through its sophisticated automatic gain control (AGC) circuitry before outputting them to the hearing loop.

### Connectors, controls and indicators

Below is an overview of the PDA103's connectors, pot level controls and LED indicators.

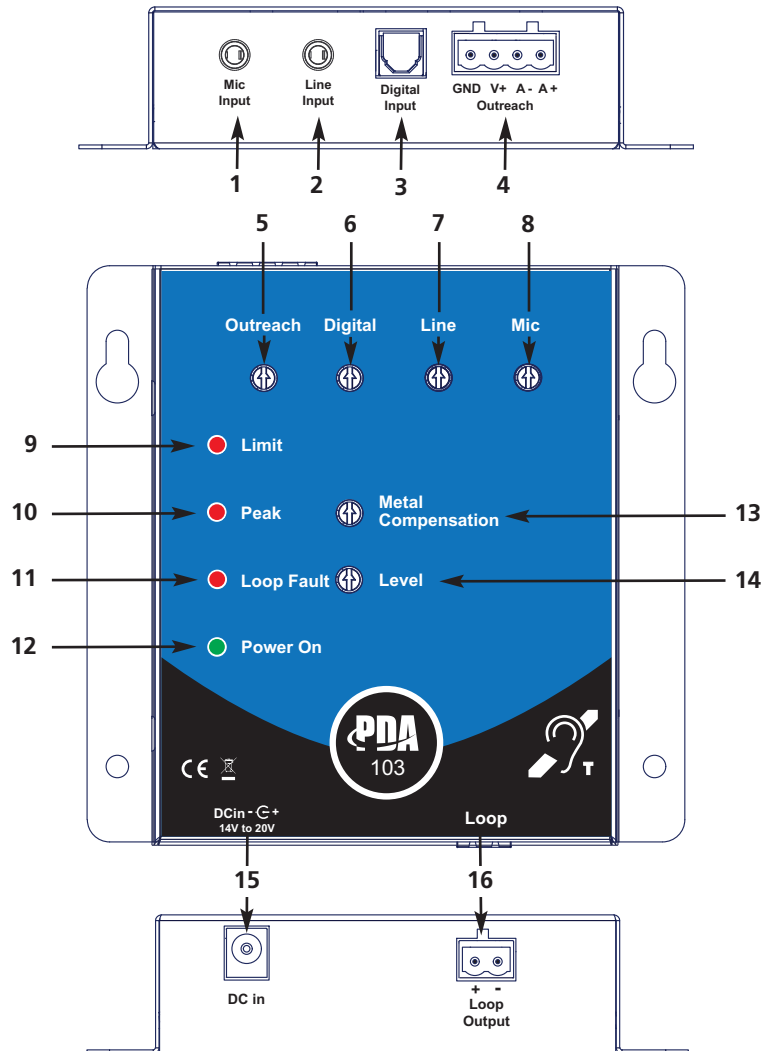

## OVERVIEW OF THE OUTREACH PLATE AUDIO EXTENSION SYSTEM

The PDA103 is fully compatible with the outreach plate audio input extension system. This system allows the connection of multiple microphones, or line level inputs via a range of specially designed wall, ceiling or desk-mountable single gang plates.

Up to ten outreach plates (any mix) can be daisy-chained to the amplifier's 'outreach' connector (supplied) with cable lengths up to 100m (total network length) easily achievable using standard two pair audio cable such as Belden 8723 - see typical wiring diagrams. Contact your supplier for more information.

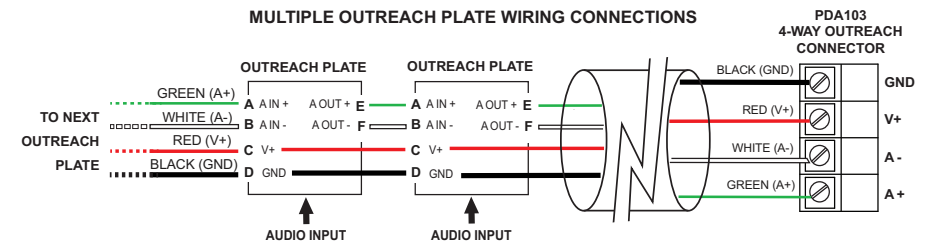
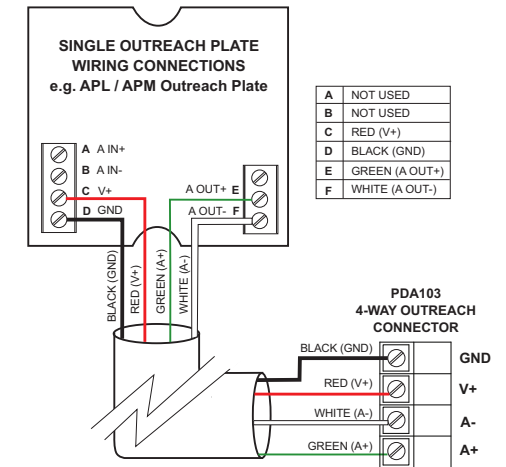

### MOUNTING THE AMPLIFIER

The amplifier can be surface-mounted in any orientation, provided the controls are accessible and indicators clearly visible.

#### Surface-mounting

Using mounting screws (not supplied) fix the amplifier securely to a wall, desk or side of counter, as appropriate. Always assess the condition and construction of the mounting surface prior to installation and use suitable screw fixings (No. 8-10, or 4-5mm screws).

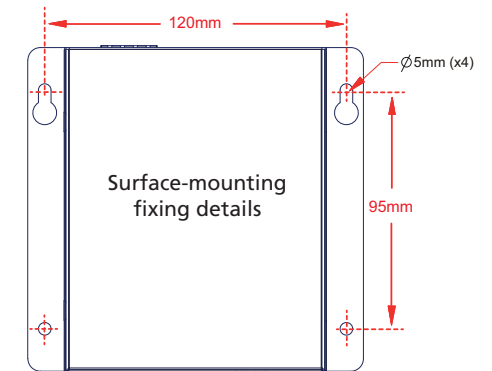

## TYPICAL PDA103S 50m<sup>2</sup> DOMESTIC TV LOUNGE HEARING LOOP SYSTEM

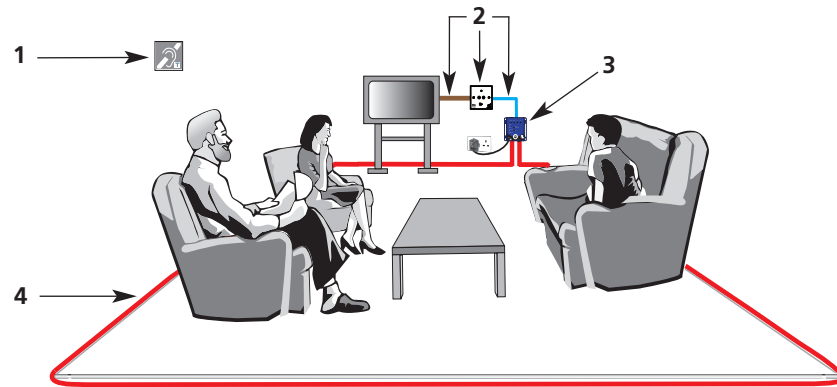

PDA103S Kit Components		
1	<b>Loop fitted sticker:</b>	Position the sticker where it can be clearly seen by hearing aid users.
2	<b>APL dual phono line level 'outreach' plate c/w APS SCART lead &amp; Belden connection cable:</b>	Surface-mount the APL plate onto a standard 25mm UK back box - a 6m length of Belden cable is provided for connecting the APL to the amplifier. The APS SCART lead (supplied), should be connected to the audio source (normally a TV) and the APL plate.
3	<b>Amplifier location:</b>	The amplifier should be surface-mounted and sited as close as possible to the equipment to which it is connected.
4	<b>Loop cable:</b>	Run the loop cable horizontally around the perimeter of the room. For best results, tuck the cable under the edge of the carpet or fixed to skirting boards or the ceiling. If installing a floor loop, ensure the loop cable is protected from being crushed in walkways or by furniture.

**Note:** As an alternative to using the APL plate, the amplifier supplied with the PDA103S kit has a TOS-link digital connector and most modern televisions can be directly connected to the amplifier using a TOS-link cable (not supplied).

Inputs & Input Controls		
1	<b>Mic input:</b>	3.5mm mono jack input supplied with 12V phantom power for use with electret microphones. Note that dynamic microphones are NOT compatible with this input.
8	<b>Mic control:</b>	Adjusts the sensitivity of microphone level input.
2	<b>Line input:</b>	3.5mm stereo jack input for connecting an audio (line) source.
7	<b>Line control:</b>	Adjusts the sensitivity of the audio line level input.
3	<b>Digital input:</b>	TOS-link digital input (PDA103S kit only).
6	<b>Digital control:</b>	Adjusts the sensitivity of the TOS-link input (PDA103S kit only).
4	<b>Outreach input:</b>	4-way input for the outreach plate audio input system.
5	<b>Outreach control:</b>	Adjusts the sensitivity of the outreach input.
15	<b>DC in:</b>	2.5mm DC power supply connector. Only connect the supplied plug-top power supply to the amplifier.

Outputs & Output Controls		
16	<b>Loop output:</b>	2-way loop connection.
13	<b>Metal Compensation control:</b>	In applications with high metal content, this control can be used to help combat the frequency response problems caused by metal 'absorbing' the magnetic field.
14	<b>Level control:</b>	Adjusts the strength of the magnetic field generated by the hearing loop.

Indicators		
9	<b>Limit:</b>	Lights red to confirm the AGC circuitry is functioning.
10	<b>Peak:</b>	Lights red in line with peaks in the input signal(s).
11	<b>Loop Fault:</b>	Lights red when the hearing loop is unintentionally connected to an input ground. To rectify, turn off the AC mains and check for loop wiring faults before reapplying power.
12	<b>Power On:</b>	Lights green when the amplifier is receiving power.

## TYPICAL PDA103C 1.2m<sup>2</sup> COUNTER HEARING LOOP SYSTEM

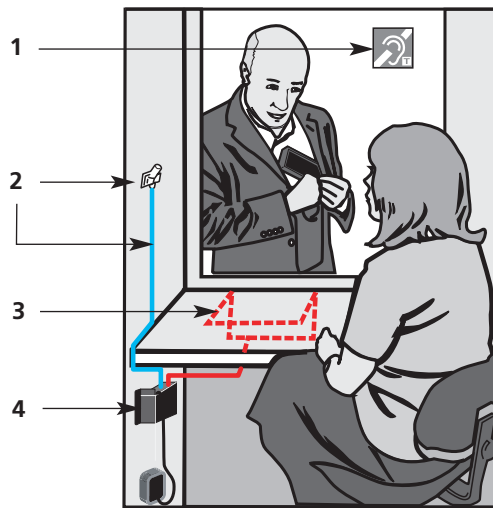

### ! MULTIPLE COUNTER LOOPS

If multiple counter loops are required in close proximity, it is possible that the 'field' generated by one system may be picked up by a person who is standing at the next. Adjust the field strength and loop shape to avoid this.

## TYPICAL PDA103R 50m<sup>2</sup> SMALL ROOM HEARING LOOP SYSTEM (plated mic version)

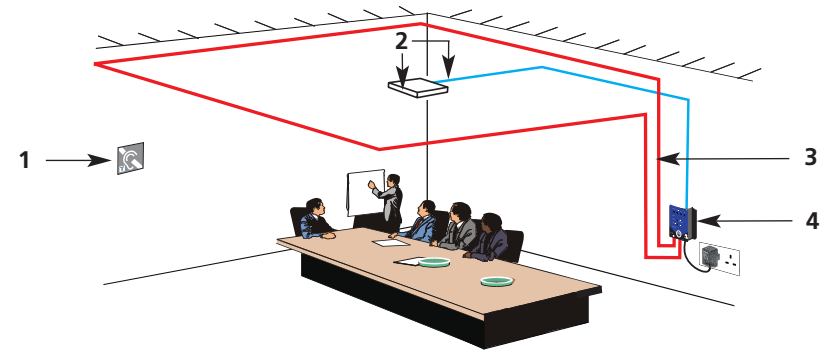

## TYPICAL PDA103L 50m<sup>2</sup> SMALL ROOM HEARING LOOP SYSTEM (tie/desk mic version)

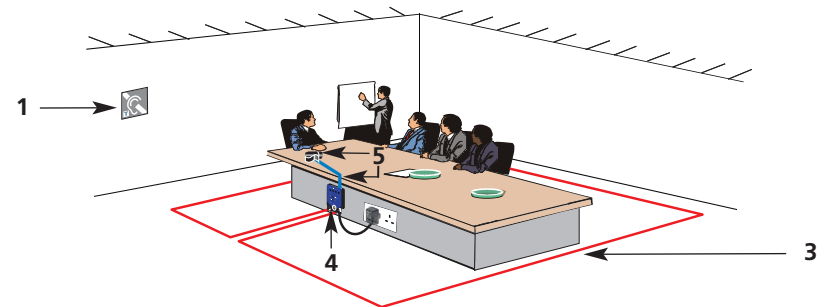

PDA103C Kit Components		
1	<b>Loop fitted sticker:</b>	Position the sticker where it can be clearly seen by hearing aid users.
2	<b>AMT tie/desk microphone c/w 1.5m lead:</b>	Position the mic as close as possible to mouth height using the self-adhesive pad (supplied). For best results position it no nearer than 300mm and no further than 1.2m distance from the operator's mouth. Avoid mounting it near sources of unwanted noise, e.g. a cooling fan, or a telephone.
3	<b>Loop cable:</b>	Fix the pre-formed TX2 counter loop (supplied) to the underside of the counter, desk or table.  For best results in counter applications: Bend the opened out 'squared' loop at a right angle half way down its length. Secure half the square to the underside of the desk and run the other half down the inside of the back vertical surface.  For best results in desk/table applications: Secure the opened out 'squared' loop to the underside of the table at the end nearest to the hearing aid user. Another option is to fit the loop above a suspended ceiling. Again, position the loop so that it is central to where the hearing aid user would naturally stand.
4	<b>Amplifier location:</b>	Mount the amplifier to the side of the counter using suitable screws.

PDA103R / PDA103L Kit Components		
1	<b>Loop fitted sticker:</b>	Position the sticker where it can be clearly seen by hearing aid users.
2	<b>APM 'outreach' plated microphone c/w Belden connection cable:</b>	For best results it should be mounted on a standard 25mm back box, ideally on a suspended ceiling height of 2.5 to 3m although it can also be surface-mounted. If mounting the microphone at ceiling height, avoid positioning it too close to ventilators, or air conditioning ducts. 6m of Belden cable is included for connecting the APM to the amplifier.
3	<b>Loop cable:</b>	Run the loop cable horizontally around the perimeter of the room, ideally located at ceiling height (e.g. above a suspended ceiling) or tucked under the edge of a carpet, or fixed to skirting boards. If installing a floor loop, ensure the loop cable is protected from being crushed in walkways, or by furniture.
4	<b>Amplifier location:</b>	Surface-mount the amplifier using suitable mounting screws. PDA103R only: To avoid unsightly connection leads, the amplifier may be mounted above a suspended ceiling, particularly if a ceiling loop is fitted to reduce wiring runs.
5	<b>AMT tie/desk microphone c/w 1.5m lead:</b>	Position the microphone as close as possible to the user using the self-adhesive pad (supplied). For best results position it no nearer than 300mm and no further than 1.2m distance from the operator's mouth. Avoid mounting it near sources of unwanted noise, e.g. a cooling fan, or a telephone.